

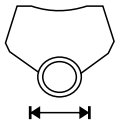

SQ15

Para cadeiras de
estrutura tubular

PRODÍZIOS
Squadroni



Diâmetro da Roldana
15 mm

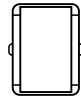

Largura
29 mm

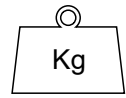



Capacidade
25 Kg

Fixação e Acabamento



Cores

Roldanas	Preta, Grafite, Cinza e Branca
	Produzido em Polipropileno ou Nylon Pista H (Rígida) - Uso em pisos acarpetados
Carcaça	Preta, Grafite, Cinza e Branca
	Produzido em Polipropileno ou Nylon

Opcionais

Outras cores sob consulta





SQ34

Móveis em geral



Diâmetro da Roldana
34 mm

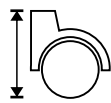

Altura
38 mm

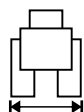

Largura
24 mm

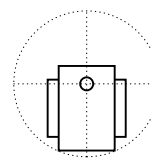

Raio de Giro
33 mm

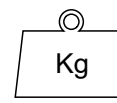

Capacidade
25 Kg

Fixação e Acabamento

	HG	HC	Fixo
Modelo			
Dimensões	Ø 06 x 37 mm	30 x 45 mm Fixo ou colar de esferas	●
Altura em Função da Fixação	50 mm	44 mm	●
Detalhes	Para uso com buchas de engate ou redução é necessário especificar o tubo	●	●
Tratamento Superficial da Fixação	Zincado (Branco)		

Outras fixações e tratamentos de superfície sob consulta

Cores

Roldanas	Pista H (Rígida) Uso em pisos acarpetados
	Polipropileno
	Transparente



Carcaças	Croma, Branco (Zincado), Branco (Pintado) e Preto
	Estampada em aço.



SQ35 Gel

Móveis em geral



Diâmetro da Roldana
35 mm

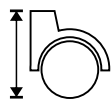

Altura
47 mm

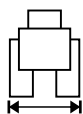

Largura
35 mm

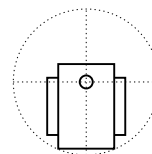

Raio de Giro
37 mm - 54 mm com freio

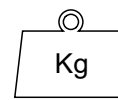

Capacidade
40 Kg

Fixação e Acabamento

Modelo	HC	
Dimensões	42 x 42 mm Colar de esferas	
Altura em Função da Fixação	50 mm	
Tratamento Superficial da Fixação	Zincado branco	

Cores

Roldanas	
	Pista W (Macia) Uso em pisos laminados de madeira, assoalhos, frios
Carcaças	Croma, Branco (Zincado), Branco (Pintado) e Preto
	Estampada em aço.



Modelo com Freio





SQ40

Móveis em geral

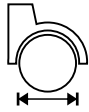

Diâmetro da Roldana
40 mm

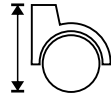

Altura
49 mm

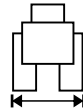

Largura
48 mm

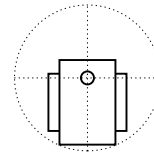

Raio de Giro
41 mm - 59 mm com freio

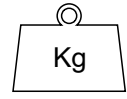

Capacidade
30 Kg

Fixação e Acabamento

	HG	HC	HR	HU	HL
Modelo					
Dimensões	Ø 6 x 37 mm Ø 6 x 46 mm Ø 6 x 50 mm Ø 7 x 50 mm	30 x 30 mm 30 x 45 mm 38 x 38 mm 42 x 42 mm	UNC 5/16" x 15 mm	13 mm 16 mm 19 mm 26 mm	16 mm
Altura em Função da Fixação	73 mm	58 mm	65 mm	58 mm	58 mm
Detalhes	Para uso com buchas de engate ou redução é necessário especificar o tubo	●	●	●	●
Pintura	●	Branco ou Preto	●	Branco ou Preto	Branco ou Preto
Tratamento Superficial da Fixação	Zincado (Branco ou Preto)				

Outras fixações e tratamentos de superfície sob consulta

Cores

Roldanas	Preta, Grafite, Cinza e Branca
	Pista H (Rígida) Uso em pisos acarpetados

Opcionais



Freio disponível em todas as versões





SQ50

Móveis
em geral

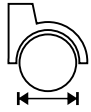

Diâmetro da Roldana
50 mm

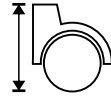

Altura
59 mm

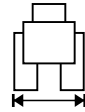

Largura
37 mm

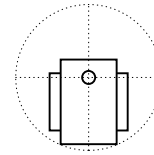

Raio de Giro
45 mm - 52 mm com freio

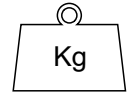

Capacidade
40 Kg

Fixação e Acabamento

	HGA	HG	HC	HR	HL
Modelo					
Dimensões	Ø 11 x 20 mm	Ø 10 x 28 mm	42 x 42 mm	M10 x 25 mm UNC 3/8 x 1" UNC 5/16" x 1	16 mm 19 mm 26 mm 30 mm
Altura em Função da Fixação	61,5 mm	61,5 mm	65 mm	67 mm	65 mm
Detalhes	Para base de nylon Anel Ø11,4 mm Para base metálicas Anel Ø11,6 mm	Para uso com buchas de engate ou redução é necessário especificar o tubo	●	●	●
Tratamento Superficial da Fixação	Zincado (Branco, Preto ou Amarelo)				

Outras fixações e tratamentos de superfície sob consulta

Cores

Roldanas	
	Pista W (Macia) Uso em pisos laminados de madeira, assoalhos, frios
Carcaças	Croma
	Estampada em aço.

Opcionais



Freio disponível em todas as versões
Consulte modelo com roldana desmontável





SQ55

Para cadeiras e
móveis em geral



Diâmetro da Roldana
55 mm

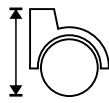

Altura
60 mm

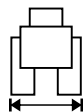

Largura
45 mm

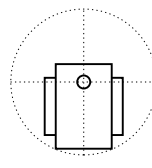

Raio de Giro
48 mm

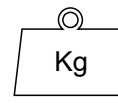

Capacidade
40 Kg

Fixação e Acabamento

	HGA	HGB	HG	HC	HR	HU/HL
Modelo						
Dimensões	Ø11 x 20 mm	Ø 11 x 20 mm	Ø 10 x 28 mm	30 x 30 mm 30 x 45 mm 38 x 38 mm 42 x 42 mm 50 x 50 mm	M10 x 25 mm UNC 3/8" x 1" UNC 5/16" x 1"	16 mm 19 mm 20 mm
Altura em Função da Fixação	61 mm	61 mm	61 mm	69 mm	66,5 mm	69 mm
Detalhes	Para bases de nylon Anel Ø 11,4 mm Para bases metálicas Anel Ø 11,6 mm	Para uso com buchas silenciadores em bases metálicas	Para uso com buchas de engate ou redução é necessário especificar o tubo	●	●	●
Pintura	●	●	●	Branco	●	Branco, Cinza ou Preto
Tratamento Superficial da Fixação	Branco, Preto ou Amarelo					

Outras fixações e tratamentos de superfície sob consulta

Cores

Roldanas	Preta, Grafite, Cinza e Branca
	Pista W (Macia) Uso em pisos laminados de madeira, assoalhos frios e etc..
	Pista H (Rígida) Uso em pisos acarpetados

Capas	Preta, Grafite, Cinza e Branca
	38 mm

Opcionais



Proteção de Roldana





SQ55Gamer

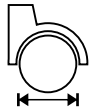

Diâmetro da Roldana
55 mm

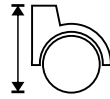

Altura
60 mm

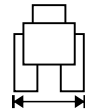

Largura
45 mm

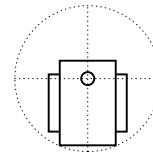

Raio de Giro
48 mm

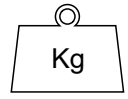

Capacidade
40 Kg

Fixação e Acabamento

	HGA	HGB	HG	HC	HR	HU/HL
Modelo						
Dimensões	Ø11 x 20 mm	Ø11 x 20 mm	Ø10 x 28 mm	30 x 30 mm 30 x 45 mm 38 x 38 mm 42 x 42 mm 50 x 50 mm	M10 x 25 mm UNC 3/8" x 1" UNC 5/16" x 1"	16 mm 19 mm 20 mm
Altura em Função da Fixação	61 mm	61 mm	61 mm	69 mm	66,5 mm	69 mm
Detalhes	Para bases de nylon Anel Ø 11,4 mm Para bases metálicas Anel Ø 11,6 mm	Para uso com buchas silenciadores em bases metálicas	Para uso com buchas de engate ou redução é necessário especificar o tubo	●	●	●
Pintura	●	●	●	Branco	●	Branco, Cinza ou Preto
Tratamento Superficial da Fixação	Branco, Preto ou Amarelo					

Outras fixações e tratamentos de superfície sob consulta

Cores

Roldanas	Preta, Grafite, Cinza e Branca
	Pista W (Macia) Uso em pisos laminados de madeira, assoalhos frios e etc..
	Pista H (Rígida) Uso em pisos acarpetados

Capas	Preta, Grafite, Cinza e Branca
	38 mm

Calotas





SQ65

Para cadeiras e
móveis em geral

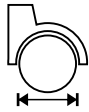

Diâmetro da Roldana
65 mm

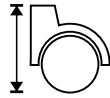

Altura
70 mm

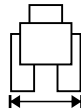

Largura
51,5 mm

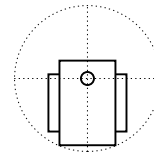

Raio de Giro
58 mm

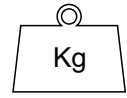

Capacidade
50 Kg

Fixação e Acabamento

	HGA	HGB	HG	HC	HR
Modelo					
Dimensões	Ø 11 x 20 mm	Ø 11 x 20 mm	Ø 10 x 28 mm	38 x 38 mm 42 x 42 mm 50 x 50 mm	UNC 3/8" x 1" UNC 5/16" x 1"
Altura em Função da Fixação	74 mm	75 mm	80 mm	80 mm	75 mm
Detalhes	Para bases de nylon Anel Ø11,4 mm Para bases metálicas Anel Ø11,6 mm	Para uso com bucha silenciadora em bases metálicas	Para uso com bucha de engate ou redução, é necessário especificar o tubo	●	●
Pintura	●	●	●	Branco	●
Tratamento Superficial da Fixação	Zincado (Branco)				

Outras fixações e tratamentos de superfície sob consulta

Cores

Roldanas	Preta, Grafite, Cinza e Branca	
	Pista W (Macia)	Uso em pisos laminados de madeira, assoalhos frios e etc..
	Pista H (Rígida)	Uso em pisos acarpetados

Opcionais

Proteção de Roldana





SQ65M

Para cadeiras e
móveis em geral



Diâmetro da Roldana
65 mm

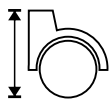

Altura
70 mm

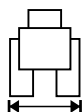

Largura
52 mm

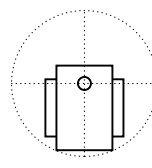

Raio de Giro
58 mm (78 mm c/ freio)

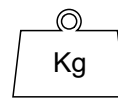

Capacidade
40 Kg

Fixação e Acabamento

	HGA	HG	HC	HR	HU	HL
Modelo						
Dimensões	Ø11 x 20 mm	Ø10 x 28 mm	38 x 38 mm 42 x 42 mm 50 x 50 mm	M10 x 25 mm UNC 3/8" x 1" UNC 5/16" x 1"	16 mm 26 mm	16 mm
Altura em Função da Fixação	74 mm	74 mm	82 mm	79,5 mm	82 mm	82 mm
Detalhes	Para bases de nylon Anel Ø 11 mm Para bases metálicas Anel Ø 11,6 mm	Para uso com buchas de engate ou redução é necessário especificar o Tubo	●	●	●	●
Pintura	●	●	Branco, Cinza ou Preto	●	Branco, Cinza ou Preto	Branco, Cinza ou Preto
Tratamento Superficial da Fixação	Zincado (Branco, Preto ou Amarelo)					

Outras fixações e tratamentos de superfície sob consulta

Cores

Roldanas	Preta, Grafite, Cinza e Branca
	Pista H (Rígida) Uso em pisos acarpetados
Calotas	Preta, Branca, Azul, Cinza Claro, Cinza Médio, Grafite, Verde, Vermelha, Cromo, Cromo Fosco, Dourado, Imbuia, Marfim, Cerejeira e Mogno

Opcionais



Freio disponível em todas as versões





Sq80

Móveis em geral



Diâmetro da Roldana
80 mm

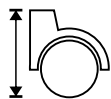

Altura
112 mm

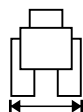

Largura
24 mm

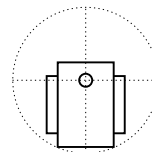

Raio de Giro
68 mm

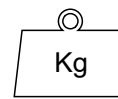

Capacidade
25 Kg

Fixação e Acabamento

	HG	HC	HR
Modelo			
Dimensões	Ø 10 x 28 mm	38 x 38 mm 42 x 42 mm	UNC 3/8" x 1" UNC 5/16" x 1"
Altura em Função da Fixação	120 mm	120 mm	116 mm
Detalhes	Para uso com bucha de engate ou redução, é necessário especificar o tubo	●	●
Pintura	●	Branco	●
Tratamento Superficial da Fixação	Zincado (Branco, Preto ou Amarelo)		

Outras fixações e tratamentos de superfície sob consulta

Cores

Roldanas	Preta, Grafite, Cinza e Branca
	Pista H (Rígida) Uso em pisos acarpetados

Calotas	Preta, Branca, Azul, Cinza Claro, Cinza Médio, Grafite, Verde, Vermelha Cromo Fosco, Dourado, Imbuia, Marfim, Cerejeira e Mogno
---------	---



Carcaças	Croma
Esquerda Direita	Injetado em Zamak



SQ82

Móveis
em geral

PRODÍZIOS
Squadroni

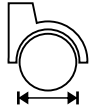

Diâmetro da Roldana
80 mm

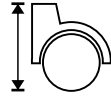

Altura
80 mm

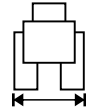

Largura
52 mm

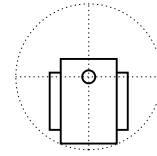

Raio de Giro
70 mm (90 mm**)

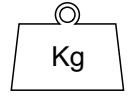

Capacidade
60 Kg

Fixação e Acabamento

	HG	HC	HR
Modelo			
Dimensões	Ø 10 x 28 mm	38 x 38 mm 42 x 42 mm 50 x 50 mm	UNC 3/8" x 1" UNC 5/16 x 1"
Altura em Função da Fixação	●	90 mm	85 mm
Detalhes	Para uso com bucha de engate ou redução, é necessário especificar o tubo	●	●
Pintura	●	Branco, Cinza ou Preto	●
Tratamento Superficial da Fixação	Zincado (Branco, Preto ou Amarelo)		

Outras fixações e tratamentos de superfície sob consulta

Cores

Roldanas	Preta, Grafite, Cinza e Branca	
	Pista W (Macia)	Uso em pisos laminados de madeira, assoalhos frios.
	Pista H (Rígida)	Uso em pisos acarpetados
Calotas	Preta, branca, cinza, grafite, croma, cromo fosco (outras cores sob consulta)	

Opcionais



Freio disponível em todas as versões





SQ90

Para cadeiras e
móveis em geral



Diâmetro da Roldana
50 mm

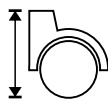

Altura
60 mm

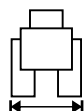

Largura
50 mm

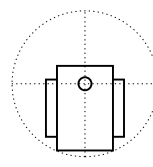

Raio de Giro
52 mm - 74 mm com freio

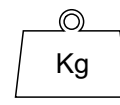

Capacidade
40 Kg

Fixação e Acabamento

	HGA	HGB	HG	HC	HR	HU/HL
Modelo						
Dimensões	Ø11 x 20 mm	Ø 11 x 20 mm	Ø 10 x 28 mm	30 x 30 mm 30 x 45 mm 38 x 38 mm 42 x 42 mm 50 x 50 mm	M10 x 25 mm UNC 3/8" x 1" UNC 5/16" x 1"	16 mm 19 mm 20 mm
Altura em Função da Fixação	63 mm	63 mm	63 mm	70 mm	64 mm	70 mm
Detalhes	Para bases de nylon Anel Ø 11,4 mm Para bases metálicas Anel Ø 11,6 mm	Para uso com buchas silenciadores em bases metálicas	Para uso com buchas de engate ou redução é necessário especificar o tubo	●	●	●
Pintura	●	●	●	Branco	●	Branco, Cinza ou Preto
Tratamento Superficial da Fixação	Zincado (Branco)					

Outras fixações e tratamentos de superfície sob consulta

Cores

Roldanas	Preta, Grafite, Cinza e Branca
	Pista W (Macia) Uso em pisos laminados de madeira, assoalhos frios e etc..
	Pista H (Rígida) Uso em pisos acarpetados

Capas	Preta, Grafite, Cinza e Branca
	38 mm
	27 mm

Opcionais



Freio disponível apenas na versão Pista H (rígida)



Calotas nas cores: Cromo, Dourada e Branca



Proteção de Roldana





SQ91

Para móveis em geral



Diâmetro da Roldana
50 mm

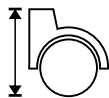

Altura
60 mm

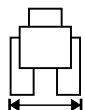

Largura
50 mm

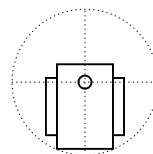

Raio de Giro
51 mm (70 mm c/ freio)

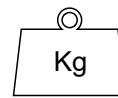

Capacidade
30 Kg

Fixação e Acabamento

	HG	HC	HR	HU	HL
Modelo					
Dimensões	Ø 7 x 28 mm Ø 10 x 28 mm	30 x 30 mm 38 x 38 mm 42 x 42 mm 50 x 50 mm 38 x 38 mm Recortada	M10 x 25 mm UNC 3/8" x 1" UNC 5/16" x 1" UNC 5/16" x 45 mm	16 mm 19 mm 20 mm 26 mm	16 mm
Altura em Função da Fixação	64 mm	72 mm	69,5 mm	72 mm	72 mm
Detalhes	Para uso com buchas de engate ou redução é necessário especificar o Tubo	●	●	●	●
Pintura	●	Branco, Cinza ou Preto	●	Branco, Cinza ou Preto	●
Tratamento Superficial da Fixação	Zincado (Branco, Preto ou Amarelo)				

Outras fixações e tratamentos de superfície sob consulta

Cores

Roldanas	Preta, Grafite, Cinza e Branca
	Pista W (Macia) Uso em pisos laminados de madeira, assoalhos frios e etc..
	Pista H (Rígida) Uso em pisos acarpetados
	Pista W Gel (Macia) Uso em pisos laminados de madeira, assoalhos frios e etc..

Capas	Preta, Grafite, Cinza e Branca
	38 mm
	27 mm

Opcionais



Freio disponível apenas na versão Pista H (rígida)



Proteção de Roldana





Sq91 Gel

Para móveis
em geral

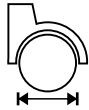

Diâmetro da Roldana
50 mm

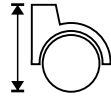

Altura
60 mm

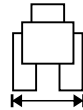

Largura
50 mm

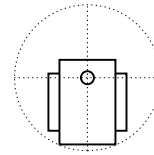

Raio de Giro
51 mm (70 mm c/ freio)

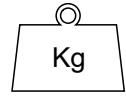

Capacidade
30 Kg

Fixação e Acabamento

Modelo	HG	HC	HR	HU	HL
Dimensões	Ø 7 x 28 mm Ø 10 x 28 mm	30 x 30 mm 38 x 38 mm 42 x 42 mm 50 x 50 mm 38 x 38 mm Recortada	M10 x 25 mm UNC 3/8" x 1" UNC 5/16" x 1" UNC 5/16" x 45 mm	16 mm 19 mm 20 mm 26 mm	16 mm
Altura em Função da Fixação	64 mm	72 mm	69,5 mm	72 mm	72 mm
Detalhes	Para uso com buchas de engate ou redução é necessário especificar o Tubo	●	●	●	●
Pintura	●	Branco, Cinza ou Preto	●	Branco, Cinza ou Preto	●
Tratamento Superficial da Fixação	Zincado (Branco, Preto ou Amarelo)				

Outras fixações e tratamentos de superfície sob consulta

Cores

Roldanas	Preta, Grafite, Cinza e Branca
	Pista W Gel (Macia) Uso em pisos laminados de madeira, assoalhos frios e etc..

Capas	Preta, Grafite, Cinza e Branca
	38 mm
	27 mm





Sq91 Gel Desmontável

For furniture
in general

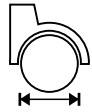

Bearing Diameter
50 mm

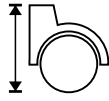

Height
60 mm

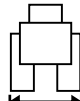

Width
50 mm

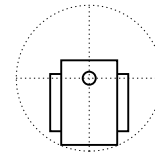

Turning Radius
51 mm (70 mm c/ freio)

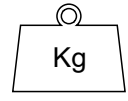

Capacity
30 Kg

Fixação e Acabamento

	HG	HC	HR	HU	HL
Modelo					
Dimensões	Ø7 x 28 mm Ø10 x 28 mm	30 x 30 mm 38 x 38 mm 42 x 42 mm 50 x 50 mm 38 x 38 mm Recortada	M10 x 25 mm UNC 3/8" x 1" UNC 5/16" x 1" UNC 5/16" x 45 mm	16 mm 19 mm 20 mm 26 mm	16 mm
Altura em Função da Fixação	64 mm	72 mm	69,5 mm	72 mm	72 mm
Detalhes	Para uso com buchas de engate ou redução é necessário especificar o Tubo	●	●	●	●
Pintura	●	Branco, Cinza ou Preto	●	Branco, Cinza ou Preto	●
Tratamento Superficial da Fixação	Zincado (Branco, Preto ou Amarelo)				

Outras fixações e tratamentos de superfície sob consulta

Cores

Roldanas	Preta, Grafite, Cinza e Branca
	Pista W Gel (Macia) Uso em pisos laminados de madeira, assoalhos frios e etc..

Capas	Preta, Grafite, Cinza e Branca
	38 mm
	27 mm

Pino Desmontável





SQ100

Para móveis em geral

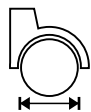

Diâmetro da Roldana
100 mm

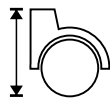

Altura
113 mm

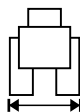

Largura
54 mm

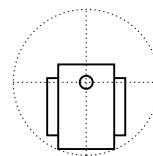

Raio de Giro
100 mm (120 mm c/ freio)

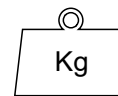

Capacidade
100 Kg

Fixação e Acabamento

	HGA	HG	HC	HR	HU
Modelo					
Dimensões	Ø11 x 20 mm	Ø 10 x 28 mm	50 x 50 mm	M10 x 25 mm UNC 3/8" x 1" UNC 5/16" x 1" UNC 1/2" x 1"	16 mm
Altura em Função da Fixação	117 mm	117 mm	125 mm	122,5 mm	125 mm
Detalhes	Para bases de nylon Anel Ø 11,4 mm Para bases metálicas Anel Ø 11,6 mm	Para uso com buchas de engate ou redução é necessário especificar o Tubo	●	●	●
Pintura	●	●	Branco, Cinza ou Preto	●	Branco, Cinza ou Preto
Tratamento Superficial da Fixação	Zincado (Branco, Preto ou Amarelo)				

Outras fixações e tratamentos de superfície sob consulta

Cores

Roldanas	Preta, Grafite, Cinza e Branca
	Pista H (Rígida) Uso em pisos acarpetados

Calotas	Preta, Branca, Azul, Cinza, Grafite, Verde, Vermelha, Cromo, Cromo Fosco, Dourado, Imbuia, Marfim, Cerejeira e Mogno
---------	--

Opcionais



Freio disponível em todas as versões





1130

Móveis em
geral

RODÍZIOS
Squadroni



Diâmetro da Roldana
30 mm

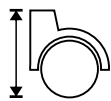

Altura
36 mm

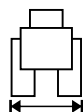

Largura
38 mm

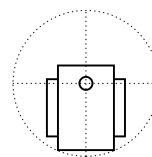

Raio de Giro
32 mm

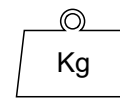

Capacidade
15 Kg

Fixação e Acabamento

	HG	HC	HR	HU
Modelo				
Dimensões	Ø 6 x 46 mm Ø 6 x 37 mm	30 x 30 mm 30 x 45 mm 38 x 38 mm	UNC 5/16" x 15 mm	16 mm 19 mm
Altura em Função da Fixação	39 mm	45 mm	47 mm	45 mm
Detalhes	Para uso com bucha de engate ou redução, é necessário especificar o tubo	●	●	●
Pintura	●	Branco ou Preto	●	Branco ou Preto
Tratamento Superficial da Fixação	Zincado (Branco)			

Outras fixações e tratamentos de superfície sob consulta

Cores

Roldanas	Preta, Grafite, Cinza e Branca
	Pista W (Macia) Uso em pisos laminados de madeira, assoalhos. frios e etc..
	Pista H (Rígida) Uso em pisos acarpetados





1135

Gaveteiros e Móveis em geral

RODÍZIOS
Squadroni

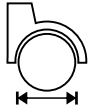

Diâmetro da Roldana
35 mm

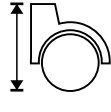

Altura
40 mm

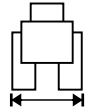

Largura
49 mm

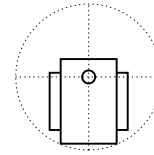

Raio de Giro
33 mm

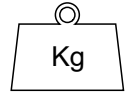

Capacidade
40 Kg

Fixação e Acabamento

	HG	HC	HR	HU	HL
Modelo					
Dimensões	Ø 10 x 28 mm	30 x 30 mm 38 x 38 mm 42 x 42 mm	UNC 3/8" x 1" UNC 5/16" x 1"	16 mm 19 mm 26 mm	16 mm 19 mm 26 mm
Altura em Função da Fixação	45 mm	48 mm	42 mm	48 mm	49,5 mm
Detalhes	Para uso com buchas de engate ou redução é necessário especificar o tubo	●	●	●	●
Pintura	●	Branco	●	Branco ou Preto	Branco ou Preto
Tratamento Superficial da Fixação	Zincado (Branco)				

Outras fixações e tratamentos de superfície sob consulta

Cores

Roldanas	Preta, Grafite, Cinza e Branca (outras cores sob consulta)
	Pista H (Rígida) Uso em pisos acarpetados





1177

Móveis em geral

PRODÍZIOS
Squadroni



Diâmetro da Roldana
49 mm

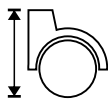

Altura
64 mm

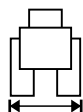

Largura
31 mm

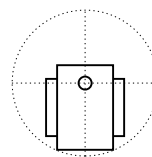

Raio de Giro
53 mm

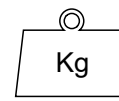

Capacidade
50 Kg

Fixação e Acabamento

	HGA	HG	HC	HR
Modelo				
Dimensões	Ø 11 x 20 mm	Ø 10 x 28 mm	38 x 38 mm	UNC 3/8" x 1" mm UNC 5/16" x 1" mm
Altura em Função da Fixação	67 mm	67 mm	69 mm	67 mm
Detalhes	●	Para uso com bucha de engate ou redução, é necessário especificar o tubo	●	●
Pintura	●	●	Branco	●
Tratamento Superficial da Fixação	Zincado (Branco ou Preto)			

Outras fixações e tratamentos de superfície sob consulta

Cores

Roldanas	Preta, Grafite, Cinza e Branca
	Pista H (Rígida) Uso em pisos acarpetados
Carcaças	Croma, Dourada, Cromo Fosco e Ouro Velho
	Injetado em Zamak



Outras cores sob consulta



1199

Móveis
em geral

PRODÍZIOS
Squadroni



Diâmetro da Roldana
45 mm

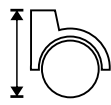

Altura
51 mm

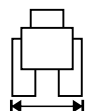

Largura
39 mm

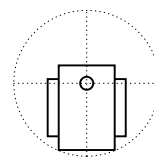

Raio de Giro
35 mm

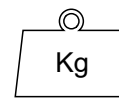

Capacidade
40 Kg

Fixação e Acabamento

	HG	HC	HR	HU	HL
Modelo					
Dimensões	Ø7 x 50 mm	30 x 30 mm 30 x 45 mm 38 x 38 mm	UNC 5/16" x 15 mm	16 mm 19 mm 26 mm	16 mm 19 mm 26 mm
Altura em Função da Fixação	59 mm	60 mm	60 mm	60 mm	60 mm
Detalhes	Para uso com buchas de engate ou redução é necessário especificar o tubo	●	●	●	●
Pintura	●	Branco ou Preto	●	Branco ou Preto	Branco ou Preto
Tratamento Superficial da Fixação	Zincado (Branco)				

Outras fixações e tratamentos de superfície sob consulta

Cores

Roldanas	Preta, Grafite, Cinza e Branca	
	Pista W (Macia) Filete TPU	Uso em pisos laminados de madeira, assoalhos frios e etc..
	Pista H (Rígida) Filete Nylon	Uso em pisos acarpetados

Carcaças	Croma, Dourada, Cromo Fosco e Ouro Velho	
Esquerda Direita	Injetado em Zamak	



Outras cores sob consulta



1800

Para cadeiras de
altas cargas

RODÍZIOS
Squadroni

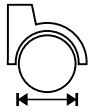

Diâmetro da Roldana
50 mm

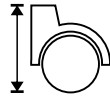

Altura
62 mm

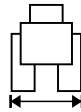

Largura
46 mm

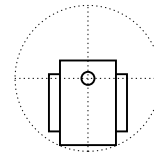

Raio de Giro
52 mm

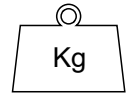

Capacidade
80 Kg

Fixação e Acabamento

Modelo	HGA
Dimensões	Ø11 x 20 mm
Altura em Função da Fixação	66 mm
Detalhes	Para bases de nylon Anel Ø 11,4 mm Para bases metálicas Anel Ø 11,6 mm
Pintura	
Tratamento Superficial da Fixação	Zincado (Branco, Preto ou Amarelo)

Outras fixações e tratamentos de superfície sob consulta

Cores

Roldanas	Preta, Grafite, Cinza e Branca
	Pista H (Rígida) Uso em pisos acarpetados

Capas	Preta, Grafite, Cinza e Branca
	38 mm
	27 mm

Opcionais

Modelo Desmontável





2035

Móveis em geral

PRODÍZIOS
Squadroni

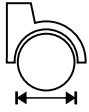

Diâmetro da Roldana
37 mm

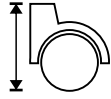

Altura
36 mm

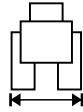

Largura
27 mm

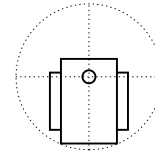

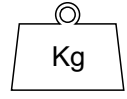

Raio de Giro
29 mm



Capacidade
40 Kg



Fixação e Acabamento

	HG	HC	HR
Modelo			
Dimensões	∅ 5 x 37 mm	30 x 30 mm 30 x 45 mm 38 x 38 mm	UNC 5/16" x 1"
Altura em Função da Fixação	37 mm	48 mm	40 mm
Detalhes	Para uso com buchas de engate ou redução é necessário especificar o tubo	●	●
Pintura	●	Branco, Cinza ou Preto	●
Tratamento Superficial da Fixação	Zincado (Branco, Preto ou Amarelo)		

Outras fixações e tratamentos de superfície sob consulta

Cores

Roldanas	Preta, Grafite, Cinza e Branca	
	Pista W (Macia) Filete TPU	Uso em pisos laminados de madeira, assoalhos frios e etc..
	Pista H (Rígida) Filete Nylon	Uso em pisos acarpetados

Carcaças	Croma, Dourada, Cromo Fosco e Ouro Velho	
 Esquerda  Direita	Injetado em Zamak	



Outras cores sob consulta



5050

Móveis em geral

PRODÍZIOS
Squadroni



Diâmetro da Roldana
50 mm

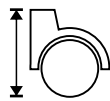

Altura
64 mm

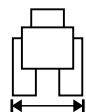

Largura
57,5 mm

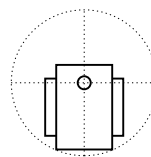



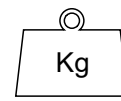

Raio de Giro
50 mm





Capacidade
50 Kg

Fixação e Acabamento

	HGA	HG	HC	HR
Modelo				
Dimensões	Ø 11 x 20 mm	Ø 10 x 28 mm	30 x 30 mm 38 x 38 mm	UNC 3/8" x 1" UNC 5/16" x 1"
Altura em Função da Fixação	68 mm	68 mm	76 mm	73,5 mm
Detalhes	Para bases de nylon Anel Ø11,4mm Para bases metálicas Anel Ø11,6 mm	Para uso com bucha de engate ou redução, é necessário especificar o tubo	●	●
Pintura	●	●	Branco	●
Tratamento Superficial da Fixação	Zincado (Branco ou Preto)			

Outras fixações e tratamentos de superfície sob consulta

Cores

Roldanas	Preta
	Pista H (Rígida) Uso em pisos acarpetados
Carcaças	Croma, Dourada, Cromo Fosco e Ouro Velho
	Injetado em Zamak



7500

Móveis em geral

 **PRODÍZIOS**
Squadroni

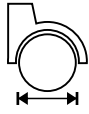

Diâmetro da Roldana
75 mm

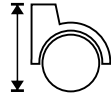

Altura
82 mm

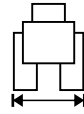

Largura
25 mm

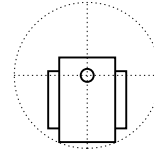

Raio de Giro
60 mm

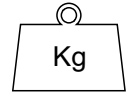



Capacidade
15 Kg

Fixação e Acabamento

Modelo	HG	HC
Dimensões	ø 10 x 32 mm	30 x 45 mm
Altura em Função da Fixação	86 mm	94 mm
Pintura	Branco, Cinza ou Preto	Branco, Cinza ou Preto
Tratamento Superficial da Fixação	Zincado (Branco)	

Outras fixações e tratamentos de superfície sob consulta

Cores

Roldanas	Pista H (Rígida) Uso em pisos acarpetados
	Preta
	Cinza - Produzida em polipropileno



Carcaças	Croma, Branco (Zincado), Branco (Pintado) e Preto
	Estampada em aço.

Outras cores sob consulta



9000 Cromas

Para móveis em geral



Diâmetro del Rodamiento
50 mm

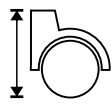

Altura
62 mm

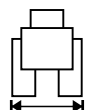

Anchura
58 mm

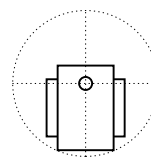

Radio de Giro
55 mm - 75 mm com freio

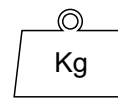

Capacidade
40 Kg

Fixação e Acabamento

	HGA	HGB	HG	HC	HR	HU/HL
Modelo						
Dimensões	Ø11 x 20 mm	Ø11 x 20 mm	Ø10 x 28 mm	30 x 30 mm 38 x 38 mm 42 x 42 mm 50 x 50 mm	UNC 3/8" x 1" UNC 5/16" x 1"	16 mm 19 mm 26 mm
Altura em Função da Fixação	64 mm	64 mm	64 mm	70 mm	64 mm	70 mm
Detalhes	Para bases de nylon Anel Ø 11,4 mm Para bases metálicas Anel Ø 11,6 mm	Para uso com buchas silenciadores em bases metálicas	Para uso com buchas de engate ou redução é necessário especificar o tubo	●	●	●
Pintura	●	●	●	Branco	●	Branco, Cinza ou Preto
Tratamento Superficial da Fixação	Zincado (Branco)					

Outras fixações e tratamentos de superfície sob consulta

Cores

Roldanas	Preta, Grafite, Cinza e Branca
	Pista W (Macia) Uso em pisos laminados de madeira, assoalhos frios e etc..
	Pista H (Rígida) Uso em pisos acarpetados

Carcaças	Croma, Fosco, Dourada, Ouro Velho
	Injetado com Zamak
Capas	Preta, Grafite, Cinza e Branca
	38 mm

Opcionais



Calotas:
Croma, Cromo Fosco, Imbuia,
Marfim, Cerejeira e Dourada



Freio disponível em todas as versões





9750

Móveis
em geral

PRODÍZIOS
Squadroni

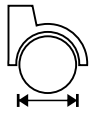

Diâmetro da Roldana
75 mm

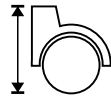

Altura
85 mm

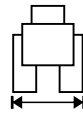

Largura
68 mm

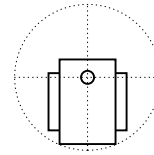

Raio de Giro
80 mm - 110 mm com freio

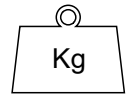

Capacidade
60 Kg

Fixação e Acabamento

	HGA	HG	HC	HR
Modelo				
Dimensões	Ø 11 x 20 mm	Ø 10 x 28 mm	42 x 42 mm 50 x 50 mm	M10 x 25 mm UNC 3/8" x 1" UNC 5/16 x 1"
Altura em Função da Fixação	89 mm	89 mm	97 mm	94,5 mm
Detalhes	Para bases de nylon Anel Ø 11,4 mm Para bases metálicas Anel Ø 11,6 mm	Para uso com bucha de engate ou redução, é necessário especificar o tubo	●	●
Pintura	●	●	Branco, Cinza ou Preto	●
Tratamento Superficial da Fixação	Zincado (Branco)			

* Outras fixações e tratamentos de superfície sob consulta

Cores

Roldanas	Preta, Grafite, Cinza e Branca
	Pista W (Macia) Uso em pisos laminados de madeira, assoalhos frios

Opcionais



Freio disponível em todas as versões





9800

Móveis
em geral



Diâmetro da Roldana
78 mm

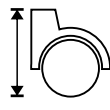

Altura
86 mm

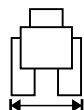

Largura
68 mm

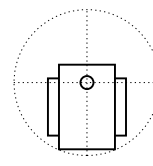

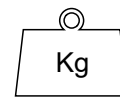

Raio de Giro
80 mm - 110 mm com freio





Capacidade
60 Kg

Fixação e Acabamento

	HG	HC	HR
Modelo			
Dimensões	Ø 10 x 28 mm	38 x 38 mm 42 x 42 mm 50 x 50 mm	UNC 3/8" x 1" UNC 5/16 x 1" UNC 5/16 x 45 mm
Altura em Função da Fixação	93 mm	96 mm	92 mm
Detalhes	Para uso com bucha de engate ou redução, é necessário especificar o tubo	●	●
Pintura	●	Branco	●
Tratamento Superficial da Fixação	Zincado (Branco)		

* Outras fixações e tratamentos de superfície sob consulta

Cores

Roldanas	Preta, Grafite, Cinza e Branca
	Pista W (Macia) Uso em pisos laminados de madeira, assoalhos frios
	Pista H (Rígida) Uso em pisos acarpetados
Calotas	Preta, branca, azul, cinza, grafite, verde, vermelha, croma, cromo fosco, dourado, imbuia, marfim, cerejeira e mogno

Opcionais



Freio disponível em todas as versões



Capa para Base

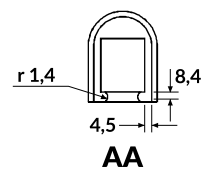
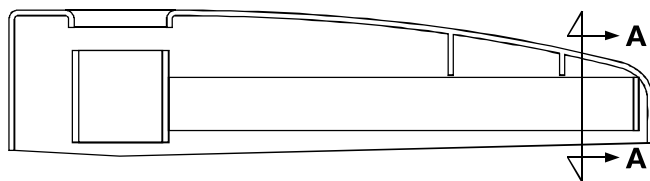

Montagem em Tubos Quadrados 1"



	Diâmetro Externo	Cores
Diretor	690 mm	Preto, Grafite, Cinza e Branco
Secretária	580 mm	

Porta CPU

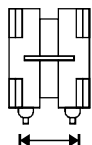

Abertura Mínima
150 mm

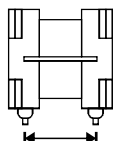

Abertura Máxima
230 mm

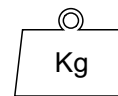

Capacidade
15 Kg

Fixação e Acabamento



Cores

Cores	Preto e Cinza
-------	---------------

Detalhes	
	Montado com 2 rodízios Sq40 com freio e 2 Sq40 sem freio.

Sapata 30x38

Para cadeiras e
móveis em geral

RODÍZIOS
Squadroni

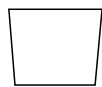

Diâmetro
38 mm

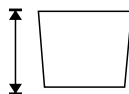



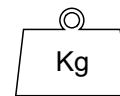

Altura
30 mm



Capacidade
100 Kg

Fixação e Acabamento

	HGA	HR	Espiga	HG
Modelo				
Dimensões	Ø11 x 20 mm	M10 x 25 mm UNC 3/8" x 1" UNC 5/16" x 1"	1/2" 10 mm 11 mm	Ø 10 x 28 mm
Detalhes	Para bases de nylon Anel Ø 11,4 mm Para bases metálicas Anel Ø 11,6 mm		Espiga de Polipropileno	Para uso com buchas de engate ou redução é necessário especificar o Tubo
Tratamento Superficial da Fixação	Zincado (Branco, Preto ou Amarelo)			

Outras fixações e tratamentos de superfície sob consulta

Cores

Preto, Grafite, Cinza e Branco

Sapata Caixa

Para cadeiras e
móveis em geral

PRODÍZIOS
Squadroni

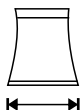

Diâmetro
52 mm

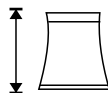

Altura
60 mm

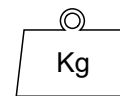

Capacidade
100 Kg

Fixação e Acabamento

	HGA	HG
Modelo		
Dimensões	ø11 x 20 mm	ø10 x 28 mm
Detalhes	Para bases de nylon Anel ø11,4 mm Para bases metálicas Anel ø11,6 mm	Para uso com buchas de engate ou redução é necessário especificar o Tubo
Tratamento Superficial da Fixação	Zincado (Branco, Preto ou Amarelo)	

Outras fixações e tratamentos de superfície sob consulta

Cores

Preto, Grafite, Cinza e Branco



Ponteira DOS

Para cadeiras e
móveis tubulares

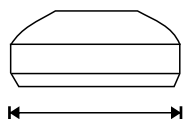

Diâmetro
35 mm

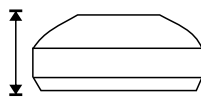

Altura
13 mm

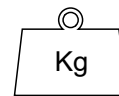

Kg
Capacidade
100 Kg

Fixação e Acabamento

	Ø 3/4"	Ø 5/8"	Ø 15,2 mm	HGA	HG	HR
Modelo						
Dimensões				Ø11 x 20 mm	Ø 10 x 28 mm	M10 x 25 mm UNC 3/8" x 1" UNC 5/16" x 1"
Detalhes	Parafuso em tubos de Ø 7/8"	Parafuso em tubos de Ø 3/4"	Parafuso em tubos de Ø 3/4" com parede de 1,9 mm	Para bases de nylon Anel Ø 11,4 mm Para bases metálicas Anel Ø 11,6 mm	Para uso com buchas de engate ou redução é necessário especificar o Tubo	●
Tratamento Superficial da Fixação	Zincado (Branco, Preto ou Amarelo)					

Outras fixações e tratamentos de superfície sob consulta

Cores

Preto, Grafite, Cinza e Branco



Ponteira 1550

Para cadeiras e
móveis tubulares

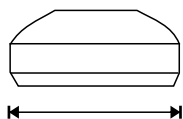

Diâmetro
50 mm

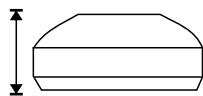

Altura
16 mm

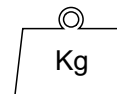

Capacidade
100 Kg

Fixação e Acabamento

	HGA	HG	HR	HGA Fixa	HG Fixa
Modelo					
Dimensões	Ø11 x 20 mm	Ø10 x 28 mm	M10 x 25 mm UNC 3/8" x 1" UNC 5/16" x 1"	Ø11 x 20 mm	Ø10 x 28 mm
Detalhes	Para bases de nylon Anel Ø 11 mm Para bases metálicas Anel Ø 11,6 mm	Para uso com buchas de engate ou redução é necessário especificar o Tubo		Para bases de nylon Anel Ø 11 mm Para bases metálicas Anel Ø 11,6 mm	Para uso com buchas de engate ou redução é necessário especificar o Tubo
Tratamento Superficial da Fixação	Zincado (Branco, Preto ou Amarelo)				

Outras fixações e tratamentos de superfície sob consulta

Cores

Preto, Grafite, Cinza e Branco



Assento Encosto Lótus

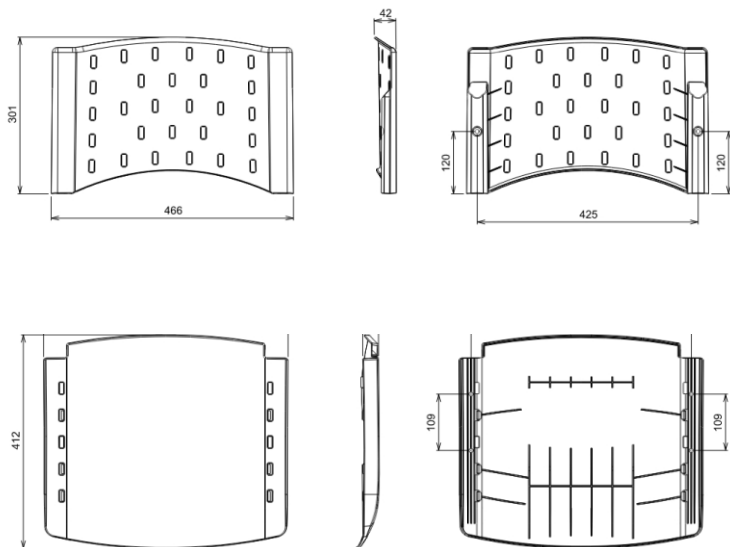

Para estruturas de aço produzidas com tubos:
 Redondo - \varnothing Ext. 7/8" (\varnothing 22,22 mm)
 Oblongos  - Ext. 16 x 30 mm



Material	Cores
Polipropileno	Preto, branco, amarelo, verde, azul, vermelho, laranja, rosa claro, azul claro, argila, grafite, bege e marrom



Base Alpha Secretária Cromada Desmontável

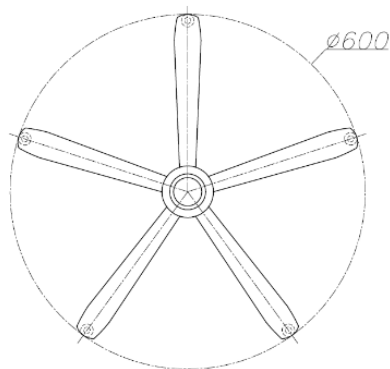

- 1 - Estrutura produzida com aço carbono tubular - espessura 1,3 mm, com elemento de junção em aço carbono 3,0 mm e buchas em aço carbono $\varnothing 11,1$ mm para alojamento do rodízio ou sapata
- 2 - Tratamento superficial cromado
- 3 - Núcleo central cone morse injetado com poliamida 6 e anel de reforço em aço
- 4 - Diâmetro 600 mm

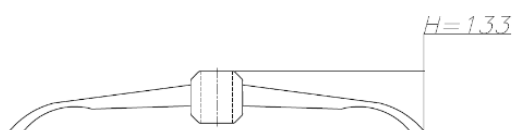

Material	Cores
Aço carbono e Poliamida	Preto e Cromado

Base Nylon Secretária

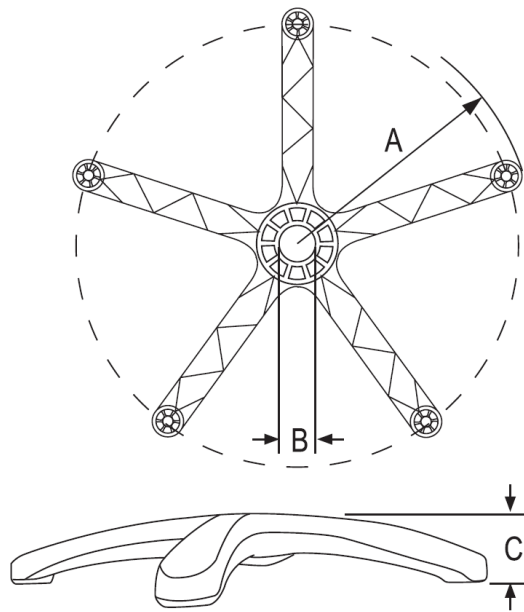

- 1 - Produzida com Poliamida 66 c/ 30% de Fibra de Vidro
- 2 - Anel de reforço central
- 3 - Dimensões:
A - 300 mm
B - 50,8 mm
C - 58 mm



Material	Cores
Poliamida e Fibra de Vidro	Preto

Capa do Assento Executivo

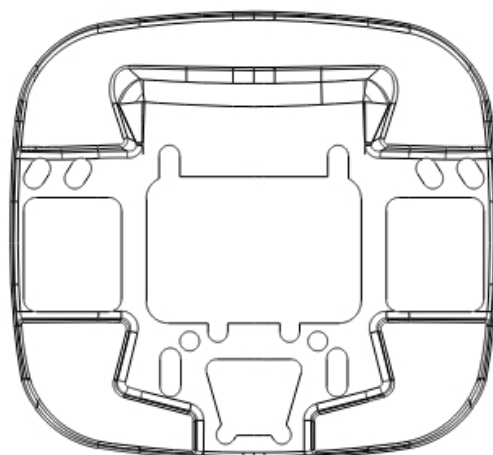
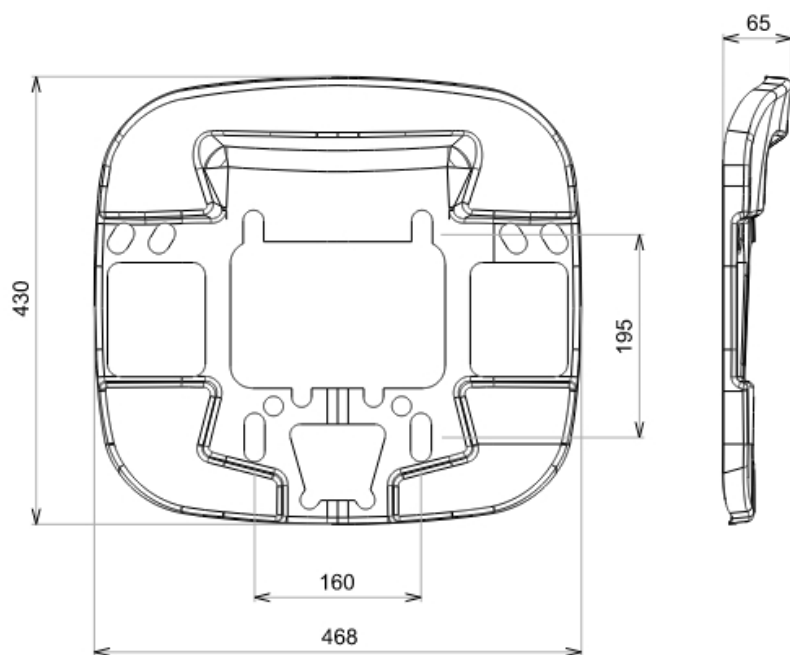
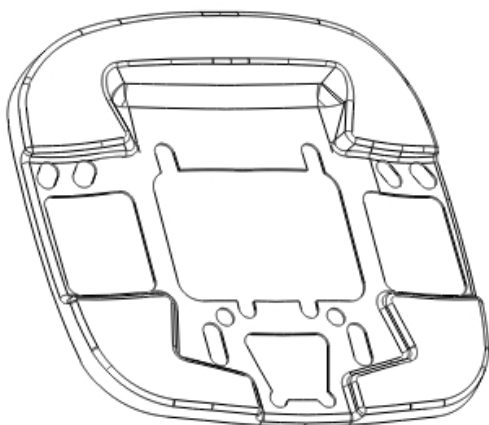

Material	Cores
Polipropileno	Preto



Capa do Encosto Executivo

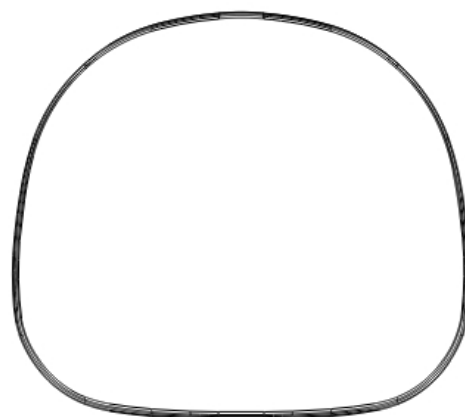
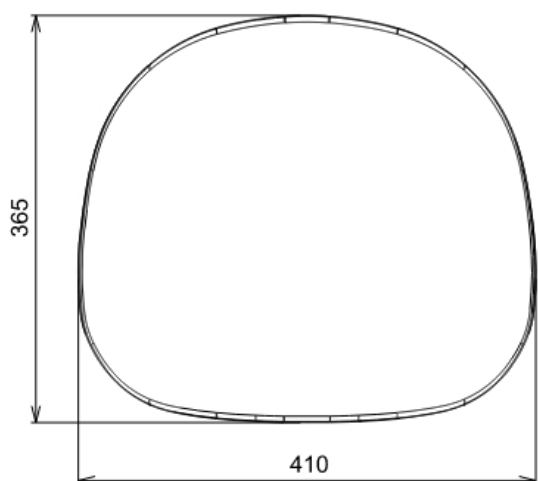
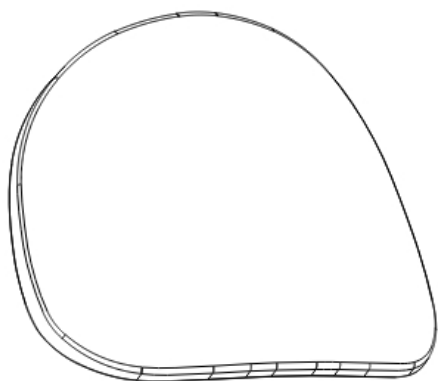

Material	Cores
Polipropileno	Preto

Encosto "L" c/ Fole - Standard

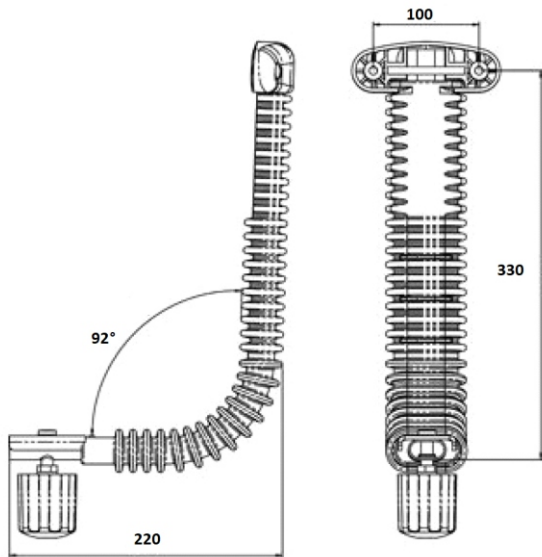

- 1 - Tubo de aço SAE 1008/1010 Oblongo
16 x 30 x 2,2 mm - pintado com tinta eletrostática pó
- 2 - Tampa do encosto em Polipropileno
- 3 - Manopla de trava em Polipropileno e fuso com
rosca m* x 1,24 mm
- 4 - Fole em Polipropileno



Material	Cores
Aço SAE e Polipropileno	Preto

Pistão a Gás

Coluna Universal - Classe III

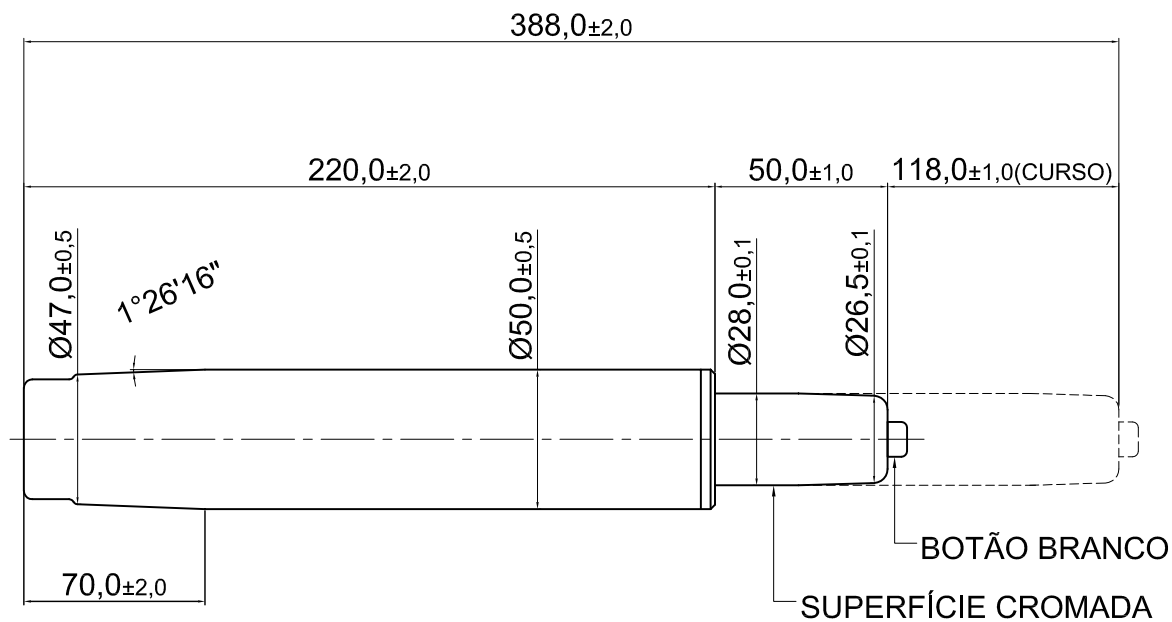

Atende a norma EN 16955:2017 - Classe III
Carga máxima de utilização 120 kg



Aplicação	Cores
Todos os tipos de flanges para cadeiras	Preto

Pistão a Gás

Coluna Universal - Classe IV

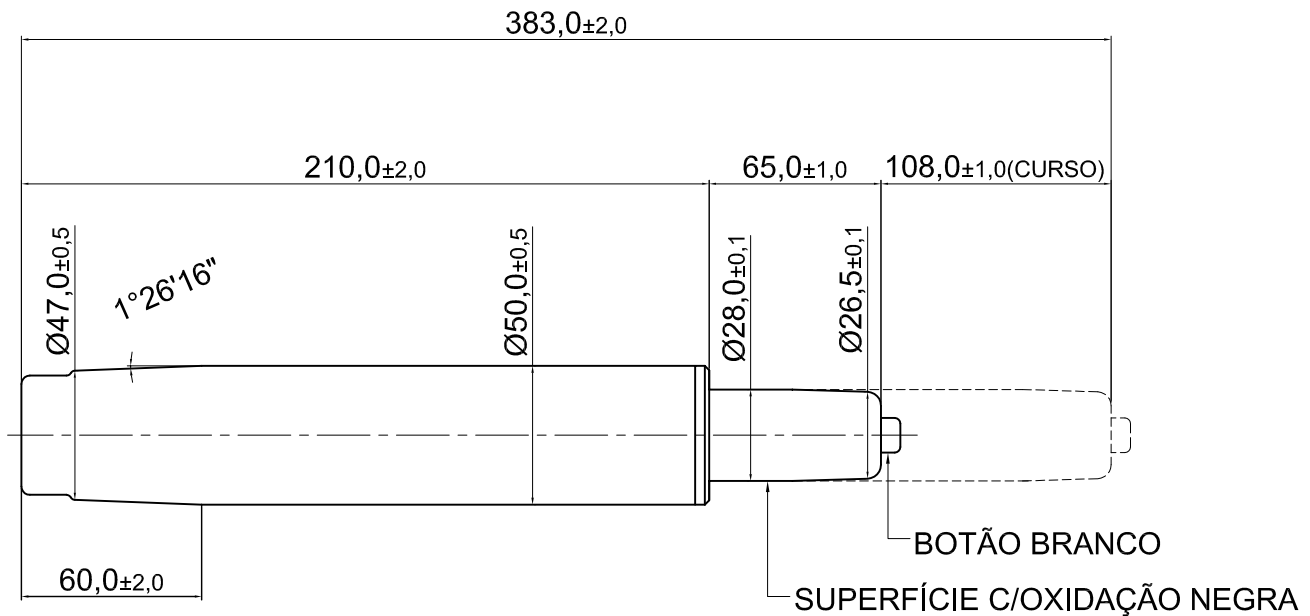

Atende a norma EN 16955:2017 - Classe IV
Carga máxima de utilização 150 kg



Aplicação	Cores
Todos os tipos de flanges para cadeiras	Preto

Porta-Objetos

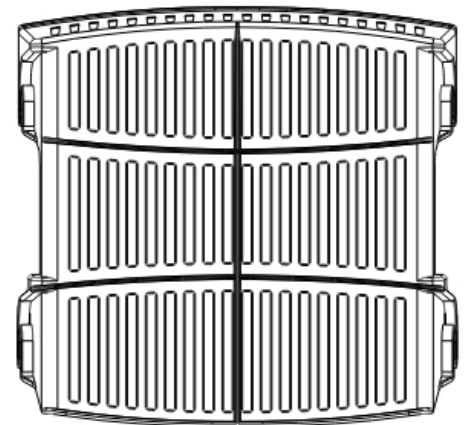
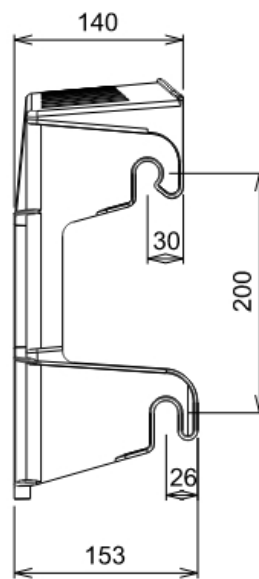
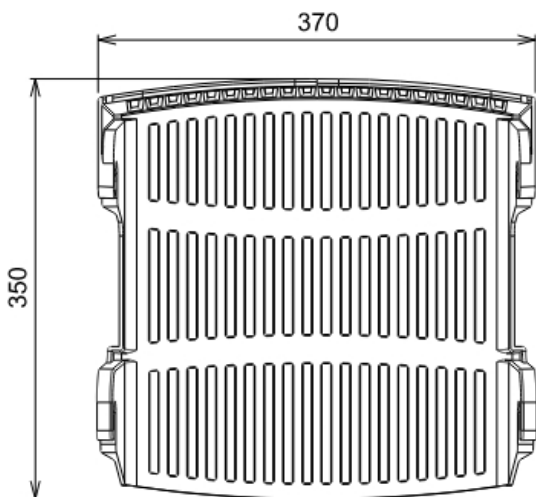
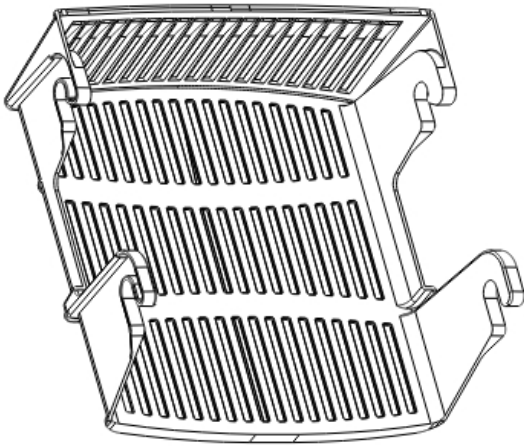

Material	Cores
Polipropileno	Preto, branco, amarelo, verde, azul, vermelho, laranja, rosa claro, azul claro, argila, grafite, bege e marrom



Prancheta Universitário Direito

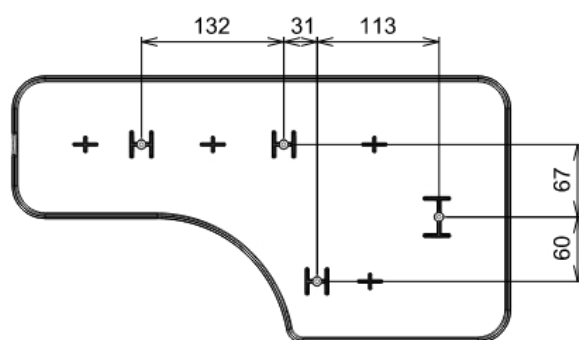
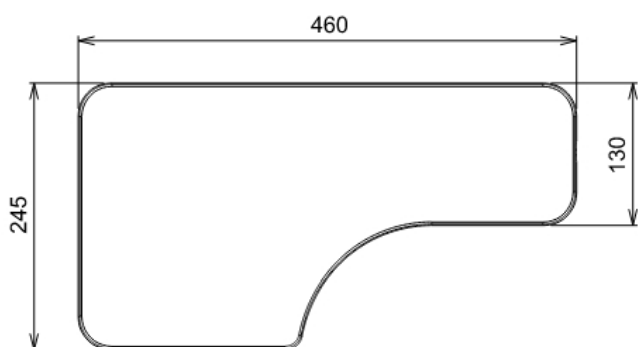

Fixação em tubo estrutural redondo - \varnothing Ext. 3/4" (\varnothing 19,05 mm)

Material	Cores
Polipropileno	Preto, branco, amarelo, verde, azul, vermelho, laranja, rosa claro, azul claro, argila, grafite, bege e marrom

Telescópio

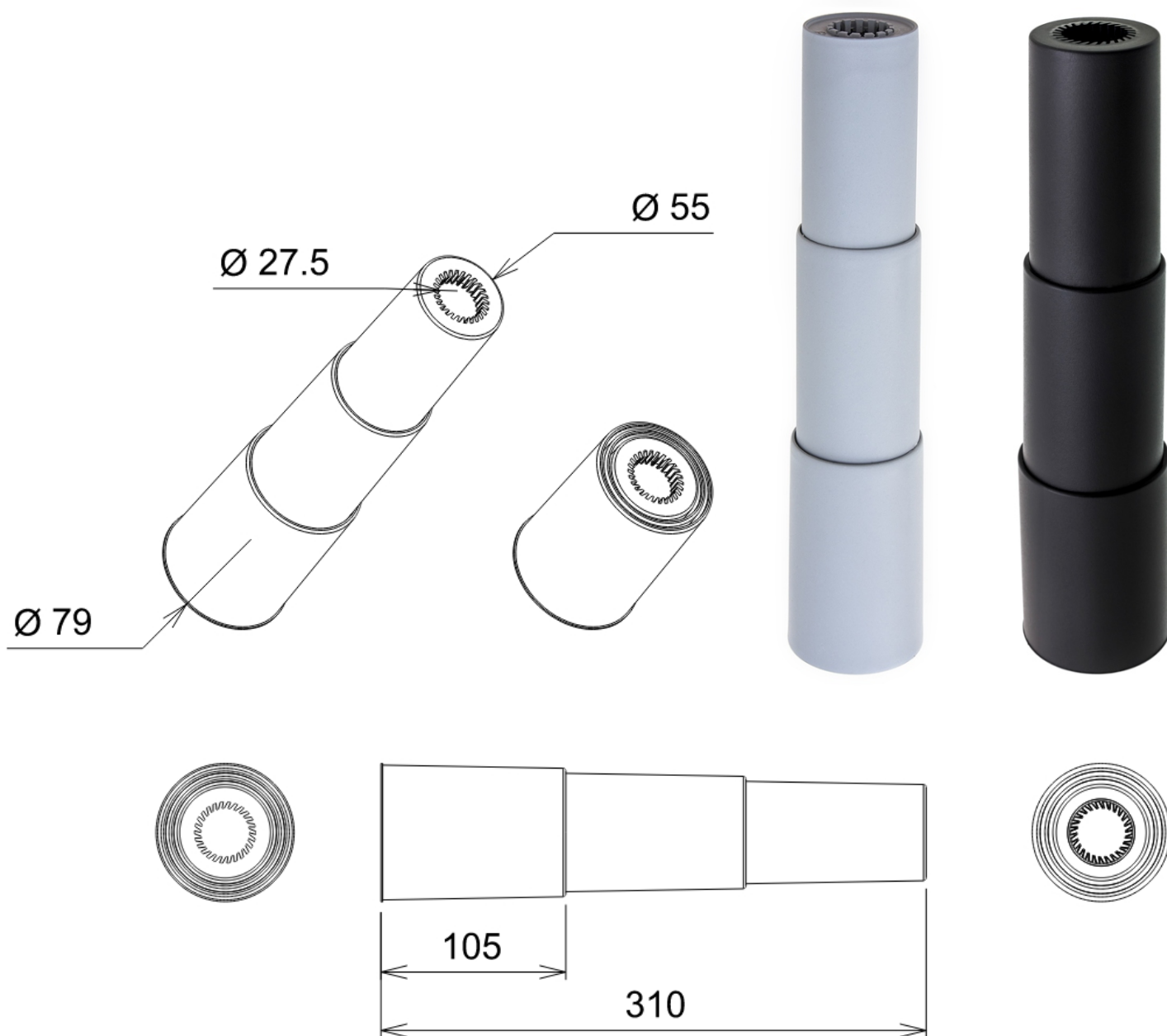

Material	Cores
Polipropileno	Preto, cinza e branco